

แบบติดตั้งระบบผลิตไฟฟ้าด้วยเซลล์แสงอาทิตย์บนหลังคา
SOLAR ROOFTOP PV POWER



DC SOLAR ENERGY





ขนาดกำลังไฟฟ้าติดตั้ง 80.40 kWp

โรงพยาบาลสองแคว อำเภอสองแคว จังหวัดน่าน

PARTS LIST

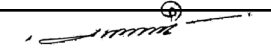
Set	DESCRIPTION	Set	DESCRIPTION	MATIRIAL
2	INVERTER HUAWEI SUN2000 40KTL M3	1	3 Phase 380 Vac	
1	SOLAR PANELS	134	SPPM 600W Monocrystalline	
1	INVERTER CABINET	1	365x364x156 mm	
1	SURGE PROTECTION AC	1	FEEO FSP-A40 20-40 KA	
1	SURGE PROTECTION DC	1	FSP-D40 Spd 20-40 KA	
1	DC FUSE	1	FEEO FDS-32B 1000VDC	
1	CIRCUIT BREAKER AC	1	RCBO CNC YCB6HLN-63 C63 63A	
1	CIRCUIT BREAKER DC	1	FEEO FPV-63 C20 20AT	
1	SMART POWER SENSOR	1	DDSU666-H 380V CT 250/5A 50/60 Hz	
1	AC Cable	1	THW 1c-10 Sqmm. Brown THW 1c-10 Sqmm. Blue	
1	DC Cable	1	Link CB1060AR-1 1x6 Sqmm. RED (30m) Link CB1060AB-1 1x6 Sqmm. Black (30m)	
1	Support & Fitting	1	MID Clamp 14 Pcs. END Clamp 4 Pcs. Solar Rial Support Au 4.7m. (4 Pcs) L Bucket Siemen 22 Pcs Gruond lug 2 Pcs Rail Earthing Clip 14 Pcs Conduit 1 " PVC / Wh 6 m /Clamp 10 Conduit 1 " 1 Pcs	
1	EARTH Cable	1	THW 1c-6 Sqmm. Yellow / Green	



DESIGNER : DC SOLAR APPROVED :  Mr.Tossapon Jarukornvanont	ELECTRICAL ENGINEER : Mr.Jittapu Sriboonrueang 	PROJECT NAME : โรงพยาบาลสองแคว 80.4 kW	REVISION :		SCALE : 1 : 1	
	PROFESSIONAL ENGINEER : Mr.Athiwat Saeio 	DRAWING TITLE : SOLAR Panel	NO	DATA	DESCRIPTION	SHEET NO : 01
	STRUCTURAL ENGINEER : Mr.Arnon Saewu 	DRAWING NAME : PARTS LIST	1		FOR QUOTATION	TOTAL SHEET :
			2			
		3				

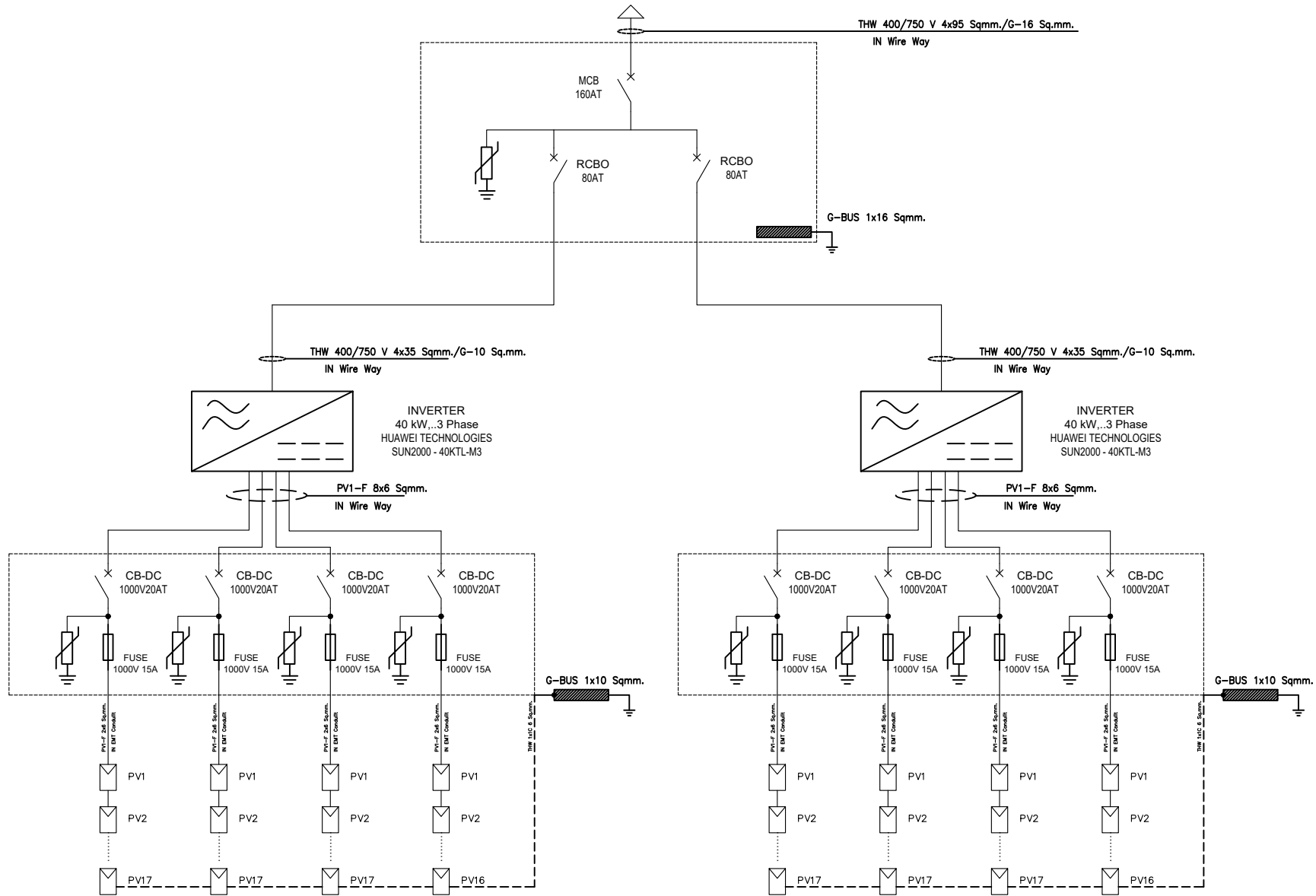

DESIGNER :
DC SOLAR

APPROVED :
 Mr.Tossapon Jarukornvanont

ELECTRICAL ENGINEER :
 Mr.Jittapu Sriboonrueang

PROFESSIONAL ENGINEER :
 Mr.Athiwat Saeieo

STRUCTURAL ENGINEER :
 Mr.Arnon Saewu

PROJECT NAME :
 โรงพยาบาลตองแคว 80.4 kW

DRAWING TITLE :
 SOLAR Panel

DRAWING NAME :

REVISION :		
NO	DATA	DESCRIPTION
1		FOR QUOTATION
2		
3		





SCALE :
 1 : 1

SHEET NO :
 02

TOTAL SHEET :

TECHNICAL SPECIFICATION

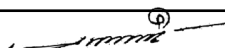
<p>PANEL BOARD (WALL MOUNTED TYPE)</p> <p><input type="checkbox"/> Indoor Form : <input type="checkbox"/> IP : 3x <input type="checkbox"/> IP : 31 <input type="checkbox"/> IP :</p> <p><input type="checkbox"/> Outdoor Form : <input type="checkbox"/> IP : 43 <input type="checkbox"/> IP : 54 <input type="checkbox"/> IP :</p> <p>SHEET STEEL : <input type="checkbox"/> ALU-ZINC <input type="checkbox"/> ELECTRO GALVANIZED <input type="checkbox"/> STAINLESS <input type="checkbox"/> # 304 <input type="checkbox"/></p> <p>COVER PLATE : <input type="checkbox"/> 1.5 mm. <input type="checkbox"/> 2.0 mm.</p> <p>TOP&BOTTOM PLATE : <input type="checkbox"/> 1.5 mm. <input type="checkbox"/> 2.0 mm.</p> <p>PARTITION PLATE : <input type="checkbox"/> 1.5 mm. <input type="checkbox"/> mm.</p> <p>INNER PLATE : <input type="checkbox"/> 1.5 mm. <input type="checkbox"/> mm.</p>	<p>PANEL BOARD (STANDING TYPE)</p> <p><input type="checkbox"/> Indoor Form : <input type="checkbox"/> IP : 3x <input type="checkbox"/> IP : 31 <input type="checkbox"/> IP :</p> <p><input type="checkbox"/> Outdoor Form : <input type="checkbox"/> IP : 43 <input type="checkbox"/> IP : 54 <input type="checkbox"/> IP :</p> <p>SHEET STEEL : <input type="checkbox"/> ALU-ZINC <input type="checkbox"/> ELECTRO GALVANIZED <input type="checkbox"/> STAINLESS <input type="checkbox"/> # 304 <input type="checkbox"/></p> <p>COVER PLATE : <input type="checkbox"/> 2.0 mm. <input type="checkbox"/> mm.</p> <p>TOP&BOTTOM PLATE : <input type="checkbox"/> 2.0 mm. <input type="checkbox"/> mm.</p> <p>PARTITION PLATE : <input type="checkbox"/> 1.5 mm. <input type="checkbox"/> mm.</p> <p>INNER PLATE : <input type="checkbox"/> 1.5 mm. <input type="checkbox"/> mm.</p> <p>Base frame U channel. : <input type="checkbox"/> Size 75x38x4 mm. - Hot-Dip Galvanized for Outdoor. <input type="checkbox"/> Size 100x50x5 mm. - Painted black color for Indoor. <input type="checkbox"/> Size mm.</p>	<p>COPPER BUSBAR</p> <p>High grade conductivity switchboard busbar.</p> <p>Busbar : Reference standards. <input type="checkbox"/> DIN 43 671 <input type="checkbox"/> IEC 439-1 <input type="checkbox"/></p> <p>Temperature rise of .70.. °C , Ambient temperature of .35.. °C</p> <p>Rating : <input type="checkbox"/> Bare. <input type="checkbox"/> Painted. <input type="checkbox"/> 1,000 Amp/Sq.inch.</p> <p>Plate : <input type="checkbox"/> Tin. <input type="checkbox"/> Silver.</p> <p>Code : <input type="checkbox"/> Mark. <input type="checkbox"/> Painted. <input type="checkbox"/> Heat shrinkable sleeve.</p> <p>Colour : Phase L1 <input type="checkbox"/> Brown <input type="checkbox"/></p> <p>Phase L2 <input type="checkbox"/> Black <input type="checkbox"/></p> <p>Phase L3 <input type="checkbox"/> Gray <input type="checkbox"/></p> <p>Neutral N <input type="checkbox"/> Blue <input type="checkbox"/></p> <p>Ground PE <input type="checkbox"/> Green <input type="checkbox"/></p> <p>Line L <input type="checkbox"/> Brown <input type="checkbox"/></p> <p>Neutral N <input type="checkbox"/> Blue <input type="checkbox"/></p>
<p>SWITCHBOARD (STANDING INDOOR TYPE)</p> <p>Form : 2A. <input type="checkbox"/> IP : 66 <input type="checkbox"/> IP : 31 <input type="checkbox"/> IP : 41 <input type="checkbox"/> IP :</p> <p>Self supporting metal structure floor standing modular system.</p> <p>FRAME : Aluzinc rust-proof frame C channel 50mm.x25mm.x2mm. (Unpainted)</p> <p>SHEET STEEL : ELECTRO GALVANIZED</p> <p>COVER PLATE : 2.0 mm.</p> <p>TOP&BOTTOM PLATE : 2.0 mm.</p> <p>PARTITION PLATE : 1.5 mm.</p> <p>INNER PLATE : 1.5 mm.</p> <p>Base frame U channel. : <input type="checkbox"/> Size 75x38x4 mm. - Painted black color. <input type="checkbox"/> Size 100x50x5 mm. <input type="checkbox"/> Size 50x50x15 cm.</p>	<p>SWITCHBOARD (STANDING OUTDOOR TYPE)</p> <p>Form : 2A. <input type="checkbox"/> IP : 43 <input type="checkbox"/> IP : 54 <input type="checkbox"/> IP :</p> <p>SHEET STEEL : <input type="checkbox"/> ALU-ZINC <input type="checkbox"/> ELECTRO GALVANIZED <input type="checkbox"/> STAINLESS <input type="checkbox"/> # 304 <input type="checkbox"/></p> <p>FRAME : <input type="checkbox"/> 3.0 mm. <input type="checkbox"/> mm.</p> <p>COVER PLATE : <input type="checkbox"/> 2.0 mm. <input type="checkbox"/> mm.</p> <p>TOP&BOTTOM PLATE : <input type="checkbox"/> 2.0 mm. <input type="checkbox"/> mm.</p> <p>PARTITION PLATE : <input type="checkbox"/> 1.5 mm. <input type="checkbox"/> mm.</p> <p>INNER PLATE : <input type="checkbox"/> 1.5 mm. <input type="checkbox"/> mm.</p> <p>Base frame U channel. : <input type="checkbox"/> Size 75x38x4 mm. - Hot-Dip Galvanized. <input type="checkbox"/> Size 100x50x5 mm. <input type="checkbox"/> Size mm.</p>	<p>CABLE</p> <p>Power cable. : <input type="checkbox"/> 60227 IEC 01 750V.(IEC-01) <input type="checkbox"/></p> <p>Control cable. : <input type="checkbox"/> H07V2-K 750V. <input type="checkbox"/></p> <p>Current cable size. <input type="checkbox"/> 4.0 Sq.mm. <input type="checkbox"/></p> <p>Voltage cable size. <input type="checkbox"/> 2.5 Sq.mm. <input type="checkbox"/></p> <p>Control cable size. <input type="checkbox"/> 1.5 Sq.mm. <input type="checkbox"/></p> <p>Ground cable for door size. <input type="checkbox"/> 6.0 Sq.mm. <input type="checkbox"/></p> <p>Wire marker. : <input type="checkbox"/> Hot marker. <input type="checkbox"/></p> <p>Colour. : Current cable. <input type="checkbox"/> BLACK <input type="checkbox"/></p> <p>Voltage cable. <input type="checkbox"/> BLACK <input type="checkbox"/></p> <p>Control cable 220VAC. <input type="checkbox"/> YELLOW <input type="checkbox"/></p> <p>Control cable 24VAC. <input type="checkbox"/> BLUE <input type="checkbox"/></p> <p>Control cable + VDC. <input type="checkbox"/> RED <input type="checkbox"/></p> <p>Control cable - VDC. <input type="checkbox"/> BLACK <input type="checkbox"/></p> <p>Control cable Ground. <input type="checkbox"/> GREEN <input type="checkbox"/></p>
<p>PAINTED WORK</p> <p>The dust and grease are removed effectively from the components.</p> <p>The spray is electrostatic epoxy powder paint which can penetrate even inaccessible area. Oven temperature is 180°C/10min (Indoor), 200°C/10min (Outdoor)</p> <p>Switchboard colour coated. : <input type="checkbox"/> T-WHITE indoor (RAL 7035) <input type="checkbox"/> ORANGE PEEL. <input type="checkbox"/> T-WHITE outdoor (RAL 7035) <input type="checkbox"/> <input type="checkbox"/> Gray indoor (RAL 7001) <input type="checkbox"/> Gray outdoor (RAL 7001) <input type="checkbox"/></p>	<p>STANDARD REFERENCE</p> <p>IEC (International Electrotechnical Commission)</p> <p>DIN (Deutsch Industrial Norms)</p> <p>TIS (Thai Industrial Standards)</p>	
<p>NAME PLATE</p> <p>All name plates are made from two-layer plastic. Letter and colour are as follows.</p> <p>Background colour : For Normal source. <input type="checkbox"/> BLACK <input type="checkbox"/></p> <p>For Emergency source. <input type="checkbox"/> RED <input type="checkbox"/></p> <p>Letter colour : For Normal source. <input type="checkbox"/> WHITE For Emergency source. <input type="checkbox"/> WHITE</p> <p>MIMIC</p> <p>All mimic are made from acrylic.</p> <p>Colour : For Normal source. <input type="checkbox"/> BLACK <input type="checkbox"/></p> <p>For Emergency source. <input type="checkbox"/> RED <input type="checkbox"/></p>		

	DESIGNER : DC SOLAR	ELECTRICAL ENGINEER : Mr.Jittapu Sriboonrueang 	PROJECT NAME : โรงพยาบาลตลิ่งแก้ว 80.4 kW	REVISION :	SCALE : 1 : 1	
	APPROVED :  Mr.Tossapon Jarukornvanont	PROFESSIONAL ENGINEER : Mr.Athiwat Saeio 	DRAWING TITLE : SOLAR Panel	NO	DATA	DESCRIPSTION
		STRUCTURAL ENGINEER : Mr.Arnon Saewu 	DRAWING NAME : Specsheet	1		FOR QUOTATION
				2		
			3			
					SHEET NO : 03	
					TOTAL SHEET :	

GENERAL SYMSBOL

SYMBOLS	DESCRIPTION	SYMBOLS	DESCRIPTION	SYMBOLS	DESCRIPTION	SYMBOLS	DESCRIPTION	SYMBOLS	DESCRIPTION
	CIRCUIT BREAKER 4P FIXED TYPE.		AMMETER		VENTILLATION FAN		SELECTOR SWITCH 3 POSITION 2NO		MECHANICAL INTERLOCK
	CIRCUIT BREAKER 3P FIXED TYPE.		VOLT METER		CHANGE-OVER CONTACT		SELECTOR SWITCH 2 POSITION 1NO+1NC		LATCHING DEVICE
	CIRCUIT BREAKER 2P FIXED TYPE.		AMP SELECTOR SWITCH		CONATCT NORMALLY CLOSE		TEMPERATURE ACTUATED NORMALLY CLOSE		HEATER ELEMENT
	CIRCUIT BREAKER 1P FIXED TYPE.		VOLT SELECTOR SWITCH		CONATCT NORMALLY OPEN		TEMPERATURE ACTUATED NORMALLY OPEN		PILOT LAMP
	CIRCUIT BREAKER 4P DRAW OUT TYPE.		POWER FACTOR CONTROLLER		THERMAL OVERLOAD CONTACT NORMALLY CLOSE		PRESSURE ACTUATED NORMALLY CLOSE		UNDERVOLTAGE RELEASE COIL
			POWER FACTOR METER		THERMAL OVERLOAD CONTACT NORMALLY OPEN		PRESSURE ACTUATED NORMALLY OPEN		SHUNT OPENING RELEASE COIL
			VAR METER		TIME-DELAYED ON DELAY NORMALLY CLOSE		PHOTO ACTUATED NORMALLY CLOSE		SHUNT CLOSING RELEASE COIL
	CIRCUIT BREAKER 3P DRAW OUT TYPE.		WATT METER		TIME-DELAYED ON DELAY NORMALLY OPEN		PHOTO ACTUATED NORMALLY OPEN		MOTOR MECHANISM OPERATE
			WATT-HOUR METER		TIME-DELAYED OFF DELAY NORMALLY CLOSE		LIQUID LEVEL ACTUATED NORMALLY CLOSE		TIME-DELAY DEVICE FOR UNDERVOLTAGE RELEASE COIL
			FREQUENCY METER		TIME-DELAYED OFF DELAY NORMALLY OPEN		LIQUID LEVEL ACTUATED NORMALLY OPEN		RECTIFIER
	SWITCH-DISCONNECTOR (ISOLATOR SWITCH)		HOUR COUNTER METER		PUSH BUTTON SPRING RETURN NORMALLY CLOSE		LIMIT SWITCHES OR POSITION SWITCH NORMALLY OPEN		BATTERY OF PRIMARY OR SECUNDAY CELLS
	SWITCH-DISCONNECTOR (ON-LOAD ISOLATING SWITCH)		DIGITAL METER		PUSH BUTTON SPRING RETURN NORMALLY OPEN		PLUG AND SOCKET		FUSE
	SWITCH-DISCONNECTOR WITH AUTOMATIC TRIPPING		COIL MAGNETIC CONTACTOR OR RELAY		PUSH BUTTON SPRING LOCKING NORMALLY CLOSE		TERMINAL		STARTER DIRECT ON LINE TYPE
	FUSE SWITCH		COIL TIMER RELAY		PUSH BUTTON SPRING LOCKING NORMALLY OPEN		TERMINAL STRIP TERMINAL MARKING		STARTER STAR-DELTA TYPE
	FUSE-DISCONNECTOR (FUSE ISOLATOR)		MOTOR (THREE-PHASE)		MUSHROOM HEAD PUSH LOCKING NORMALLY CLOSE		EARTH (GROUND)		TRANSFORMER
	FUSE SWITCH-DISCONNECTOR (ON-LOAD ISOLATOR FUSE ISOLATOR)				MUSHROOM HEAD PUSH LOCKING NORMALLY OPEN		SEMICONDUCTOR DIODE		
	MAGNETIC CONTACTOR		MOTOR (SINGLE-PHASE)		SELECTOR SWITCH LOCKING NORMALLY CLOSE		LIGHT EMITTING DIODE (LED)		CURRENT TRANSFORMER
	THERMAL OVERLOAD RELAY				SELECTOR SWITCH LOCKING NORMALLY OPEN		CAPACITOR		BUZZER



DESIGNER : DC SOLAR

APPROVED :
Mr.Tossapon Jarukornvanont

ELECTRICAL ENGINEER :

Mr.Jittapu Sriboonrueang

PROFESSIONAL ENGINEER :

Mr.Athiwat Saeiao

STRUCTURAL ENGINEER :

Mr.Arnon Saewu

PROJECT NAME :

โรงพยาบาลตองแคว 80.4 kW

DRAWING TITLE :

SOLAR Panel

DRAWING NAME :

Symbol

REVISION :

NO	DATA	DESCRIPSTION
1		FOR QUOTATION
2		
3		

SCALE :

1 : 1

SHEET NO :

04

TOTAL SHEET :

พิกัดการนำกระแสของ BUS BAR ตามมาตรฐาน IEC 61439-2

บาร์ทองแดงที่มีพื้นที่หน้าตัดเป็นรูปสี่เหลี่ยมติดตั้งภายในอาคาร ค่าอุณหภูมิโดยรอบ (Ambient temperature) เป็นไปตามตารางและ Temperature rise เป็น 105°C ติดตั้งในแนวดิ่ง โดยระยะห่างระหว่างบาร์ทองแดงมีค่าเท่ากับความหนาของบาร์ทองแดง ใช้กับไฟฟ้ากระแสสลับ 50 Hz ระยะห่างระหว่างเฟส > 0.8 ของกึ่งกลางระหว่างเฟสต่อเฟส

ลำดับที่	ขนาดบาร์ (mm.) กว้าง x หนา	น้ำหนัก กิโลกรัม / เมตร	การนำกระแสที่ Ambient temp 40°C และ Conductor temp 105°C (แอมแปร์)			
			จำนวนบาร์ทองแดงต่อเฟส			
			บาร์ทองแดงแบบพันสี่			
			□	□□	□□□	□□□□
1	12 x 2	0.352	195	312	362	-
2	12 x 5	0.558	322	548	653	-
3	12 x 10	1.116	518	961	1396	-
4	15 x 3	0.420	297	502	605	-
5	20 x 5	0.893	507	889	1156	-
6	20 x 10	1.785	798	1467	2096	-
7	25 x 5	1.166	610	1051	1332	-
8	30 x 5	1.339	710	1207	1499	-
9	30 x 10	2.678	1073	1906	1652	-
10	40 x 5	1.785	910	1512	1810	-
11	40 x 10	3.571	1350	2334	3176	4097
12	50 x 5	2.232	1107	1810	2112	3192
13	50 x 10	4.464	1620	2731	3684	4684
14	60 x 5	2.678	1312	2112	2398	3668
15	60 x 10	5.356	1874	3112	4145	5224
16	80 x 5	3.571	1699	2668	2906	4494
17	80 x 10	7.142	2382	3827	5034	6241
18	100 x 5	4.464	2064	3192	3414	5240
19	100 x 10	8.928	2874	4526	5907	7193
20	120 x 10	10.71	3351	5209	6781	8146
21	160 x 10	14.28	4287	6558	8511	10036
22	200 x 10	17.64	5224	7892	10211	11894

Rated current for cable		
Conductor Sq.mm. (mm ²)	Range of test current THW A (แอมแปร์)	Range of test current VSF A (แอมแปร์)
1	8	19
1.5	12	24
2.5	20	33
4	32	44
6	44	57
10	50	70
16	65	94
25	85	125
35	115	154
50	150	198
70	175	245
95	225	292
120	250	344
150	275	391
185	350	448
240	400	528

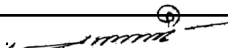

DESIGNER : DC SOLAR

APPROVED : 
Mr. Tossapon Jarukornvanont

ELECTRICAL ENGINEER :

Mr. Jittapu Sriboonrueang 

PROFESSIONAL ENGINEER :

Mr. Athiwat Saeio 

STRUCTURAL ENGINEER :

Mr. Arnon Saewu 

PROJECT NAME :

โรงพยาบาลสองแคว 80.4 kW

DRAWING TITLE :

SOLAR Panel

DRAWING NAME :

Cable List

REVISION :

NO	DATA	DESCRIPTION
1		FOR QUOTATION
2		
3		

SCALE :

1 : 1

SHEET NO :

05

TOTAL SHEET :

แสดงค่าแรงขันนัทและโบลท์แต่ละขนาด
โบลท์ GRADE 8.8

ขนาดโบลท์ และน็อต	ค่าที่ตั้งไว้ ในขณะขัน (Torque wrench)	ค่าที่ใช้ ที่ยอมรับได้ (Torque)	ค่าที่ตั้งไว้ ในขณะขัน (Torque wrench)	ค่าที่ใช้ ที่ยอมรับได้ (Torque)
	ft-lb	ft-lb	N.m	N.m
M3	1.1	0.99 - 1.21	1.5	1.35 - 1.65
M4	2.58	2.32 - 2.84	3.5	3.15 - 3.85
M5	5.16	4.64 - 5.68	7	6.3 - 7.7
M6	9.58	8.62 - 10.54	13	11.7 - 14.3
M8	20.64	18.58 - 22.54	28	25.2 - 30.8
M10	36.86	33.17 - 40.55	50	45 - 55
M12	55.29	49.76 - 60.82	75	67.5 - 82.5
M14	88.47	79.62 - 97.32	120	108 - 132
M16	136.4	122.76 - 150.04	185	166.5 - 203.5
M18	191.69	172.52 - 210.86	260	234 - 286
M20	272.8	245.52 - 300.08	370	333 - 407



DESIGNER : DC SOLAR

APPROVED : 
Mr.Tossapon Jarukornvanont

ELECTRICAL ENGINEER :
Mr.Jittapu Sriboonrueang 

PROFESSIONAL ENGINEER :
Mr.Athiwat Saeio 

STRUCTURAL ENGINEER :
Mr.Arnon Saewu 

PROJECT NAME :
โรงพยาบาลสองแคว 80.4 kW

DRAWING TITLE :
SOLAR Panel

DRAWING NAME :
Manual List

REVISION :

NO	DATA	DESCRIPTION
1		FOR QUOTATION
2		
3		

SCALE :
1 : 1

SHEET NO :
06

TOTAL SHEET :

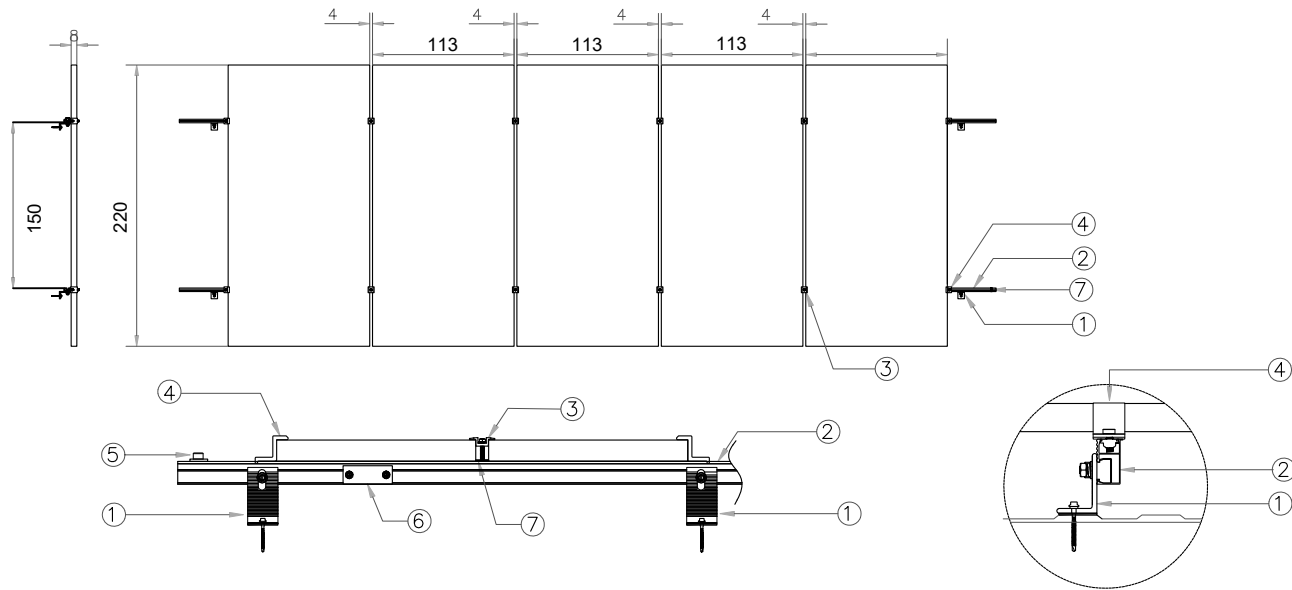

Item	Model	Description	Material	Remark
1	GM-MRH-L5	L BRACKET WITH HOLE	ALUMINIUM ALLOY&STAINLESS STEEL	
		EPDM RUBBER	RUBBER	
		SELF DRILLING SCREW M6.3x75 mm.	ZINC PLATED STEEL	
2	GM-R02-LIGHT	RAIL	ANODIZED AL6005-T5	
3	GM-MC-40	MID CLAMP	ANODIZED AL6005-T5	
4	GM-EC-40	END CLAMP	ANODIZED AL6005-T5	
5	GM-EK	GROUND LUG	ANODIZED AL6005-T5/SUS 304	
6	GM-RS-01-L-150	RAIL JOINT PLATE	ALUMINIUM ALLOY&STAINLESS STEEL	
7	GM-E-EL-04	RAIL EARTHING CLIP	SUS 304	

<table border="1"> <thead> <tr> <th>Item</th> <th>Model</th> <th>Description</th> <th>Material</th> <th>Remark</th> </tr> </thead> <tbody> <tr> <td>1</td> <td>GM-MRH-L5</td> <td>L BRACKET WITH HOLE DRAW RUBBER SELF DRILLING SCREW</td> <td>ALUMINIUM ALLOY RUBBER ZINC PLATED STEEL</td> <td></td> </tr> </tbody> </table>	Item	Model	Description	Material	Remark	1	GM-MRH-L5	L BRACKET WITH HOLE DRAW RUBBER SELF DRILLING SCREW	ALUMINIUM ALLOY RUBBER ZINC PLATED STEEL		<table border="1"> <thead> <tr> <th>Item</th> <th>Model</th> <th>Description</th> <th>Material</th> <th>Remark</th> </tr> </thead> <tbody> <tr> <td>2</td> <td>GM-R02-LIGHT</td> <td>RAIL</td> <td>ANODIZED AL6005-T5</td> <td></td> </tr> </tbody> </table>	Item	Model	Description	Material	Remark	2	GM-R02-LIGHT	RAIL	ANODIZED AL6005-T5	
Item	Model	Description	Material	Remark																	
1	GM-MRH-L5	L BRACKET WITH HOLE DRAW RUBBER SELF DRILLING SCREW	ALUMINIUM ALLOY RUBBER ZINC PLATED STEEL																		
Item	Model	Description	Material	Remark																	
2	GM-R02-LIGHT	RAIL	ANODIZED AL6005-T5																		
<table border="1"> <thead> <tr> <th>Item</th> <th>Model</th> <th>Description</th> <th>Material</th> <th>Remark</th> </tr> </thead> <tbody> <tr> <td>3</td> <td>GM-MC-40</td> <td>MID CLAMP</td> <td>ANODIZED AL6005-T5</td> <td></td> </tr> </tbody> </table>	Item	Model	Description	Material	Remark	3	GM-MC-40	MID CLAMP	ANODIZED AL6005-T5		<table border="1"> <thead> <tr> <th>Item</th> <th>Model</th> <th>Description</th> <th>Material</th> <th>Remark</th> </tr> </thead> <tbody> <tr> <td>4</td> <td>GM-EC-40</td> <td>END CLAMP</td> <td>ANODIZED AL6005-T5</td> <td></td> </tr> </tbody> </table>	Item	Model	Description	Material	Remark	4	GM-EC-40	END CLAMP	ANODIZED AL6005-T5	
Item	Model	Description	Material	Remark																	
3	GM-MC-40	MID CLAMP	ANODIZED AL6005-T5																		
Item	Model	Description	Material	Remark																	
4	GM-EC-40	END CLAMP	ANODIZED AL6005-T5																		
<table border="1"> <thead> <tr> <th>Item</th> <th>Model</th> <th>Description</th> <th>Material</th> <th>Remark</th> </tr> </thead> <tbody> <tr> <td>5</td> <td>GM-EK</td> <td>GROUND LUG</td> <td>ANODIZED AL6005-T5/SUS 304</td> <td></td> </tr> </tbody> </table>	Item	Model	Description	Material	Remark	5	GM-EK	GROUND LUG	ANODIZED AL6005-T5/SUS 304		<table border="1"> <thead> <tr> <th>Item</th> <th>Model</th> <th>Description</th> <th>Material</th> <th>Remark</th> </tr> </thead> <tbody> <tr> <td>6</td> <td>GM-RS-01-L-150</td> <td>RAIL JOINT PLATE</td> <td>ALUMINIUM ALLOY</td> <td></td> </tr> </tbody> </table>	Item	Model	Description	Material	Remark	6	GM-RS-01-L-150	RAIL JOINT PLATE	ALUMINIUM ALLOY	
Item	Model	Description	Material	Remark																	
5	GM-EK	GROUND LUG	ANODIZED AL6005-T5/SUS 304																		
Item	Model	Description	Material	Remark																	
6	GM-RS-01-L-150	RAIL JOINT PLATE	ALUMINIUM ALLOY																		
<table border="1"> <thead> <tr> <th>Item</th> <th>Model</th> <th>Description</th> <th>Material</th> <th>Remark</th> </tr> </thead> <tbody> <tr> <td>7</td> <td>GM-E-EL-04</td> <td>RAIL EARTHING CLIP</td> <td>SUS 304</td> <td></td> </tr> </tbody> </table>	Item	Model	Description	Material	Remark	7	GM-E-EL-04	RAIL EARTHING CLIP	SUS 304												
Item	Model	Description	Material	Remark																	
7	GM-E-EL-04	RAIL EARTHING CLIP	SUS 304																		



DESIGNER : DC SOLAR

APPROVED : Mr.Tossapon Jarukornvanont

ELECTRICAL ENGINEER :

Mr.Jittapu Sriboonrueang

PROFESSIONAL ENGINEER :

Mr.Athiwat Saeio

STRUCTURAL ENGINEER :

Mr.Arnon Saewu

PROJECT NAME :

โรงพยาบาลสองแคว 80.4 KW

DRAWING TITLE :

SOLAR Panel

DRAWING NAME :

Manual List

REVISION :

NO	DATA	DESCRIPTION
1		FOR QUOTATION
2		
3		

SCALE :

1 : 1

SHEET NO :

07

TOTAL SHEET :

INV 40 kW

INV 40 kW

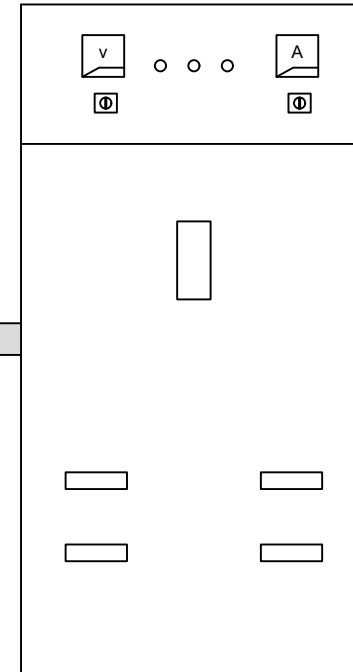
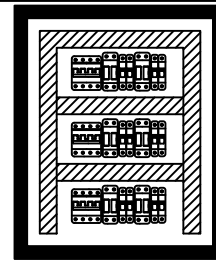
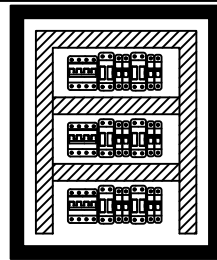
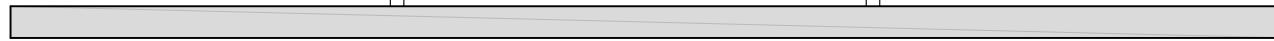
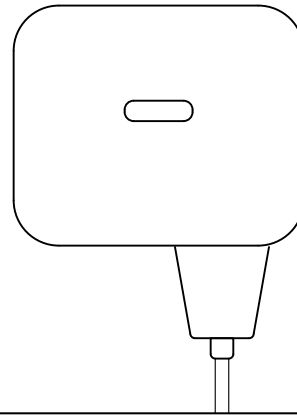
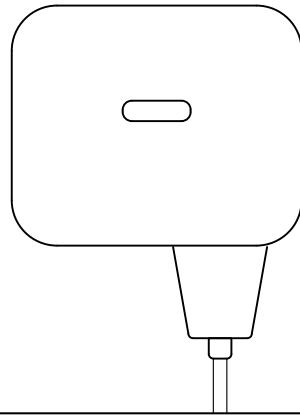

DESIGNER :
DC SOLAR

APPROVED :
Mr. Tossapon Jarukornvanont

ELECTRICAL ENGINEER :
Mr. Jittapu Sriboonrueang

PROFESSIONAL ENGINEER :
Mr. Athiwat Saeieo

STRUCTURAL ENGINEER :
Mr. Arnon Saewu

PROJECT NAME :
โรงพยาบาลสองแคว 80.4 kW

DRAWING TITLE :
SOLAR Panel

DRAWING NAME :

REVISION :		DESCRIPTION
NO	DATA	DESCRIPTION
1		FOR QUOTATION
2		
3		

SCALE :
1 : 1

SHEET NO :
08

TOTAL SHEET :

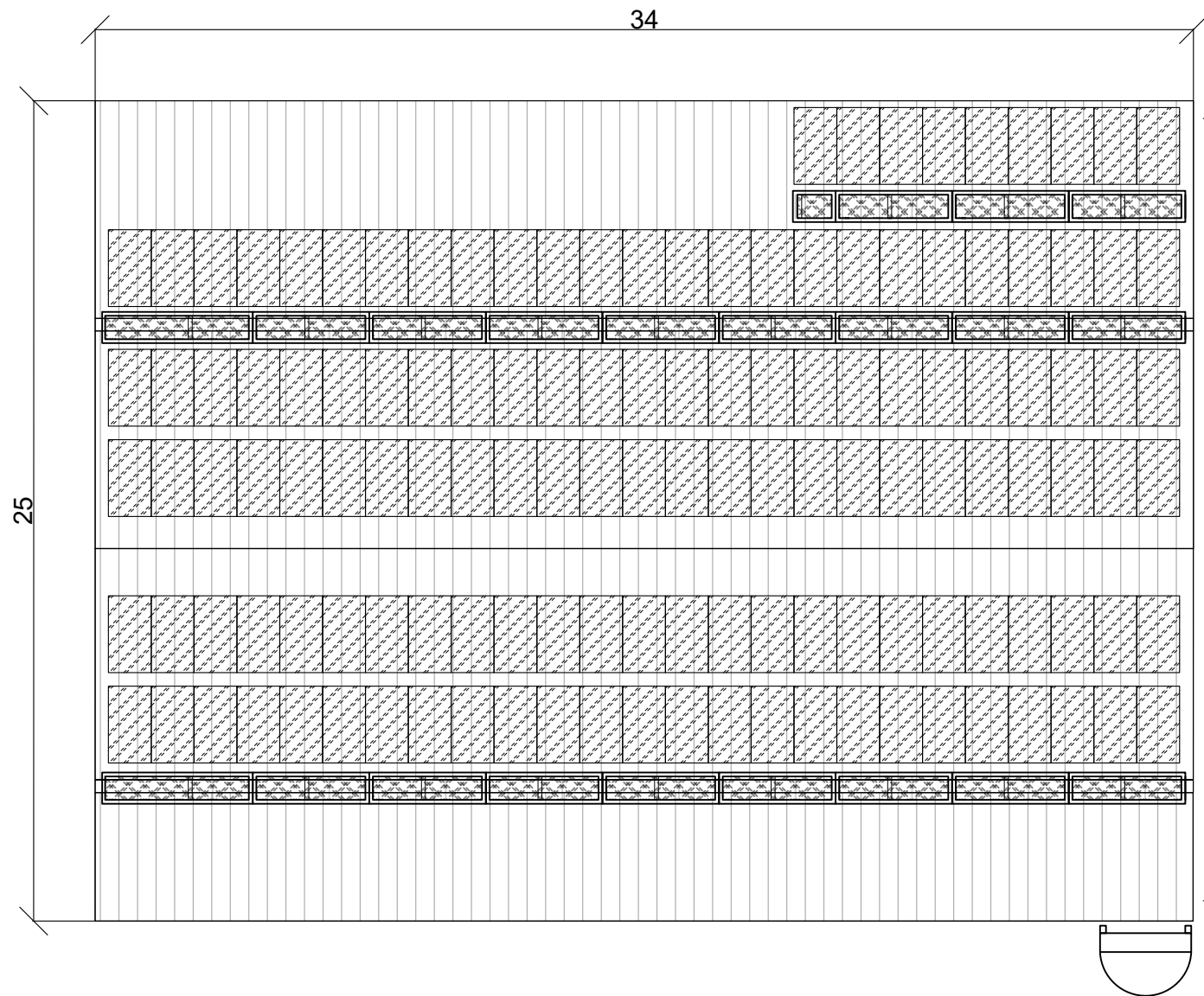

Zone A : PV = 50

Zone2 B : PV = 84

Total : PV = 134
(80.4 kW)

Zone B

INV 40 kW

INV 40 kW

Zone A

SERVICE LADDER

ผู้ว่าจ้างอนุมัติแบบ



DESIGNER :
DC SOLAR

APPROVED :
Mr. Tossapon Jarukornvanont

ELECTRICAL ENGINEER :
Mr. Jittapu Sriboonrueang

PROFESSIONAL ENGINEER :
Mr. Athiwat Saeieo

STRUCTURAL ENGINEER :
Mr. Arnon Saewu

PROJECT NAME :
โรงพยาบาลสองแคว 80.4 kW

DRAWING TITLE :
SOLAR Panel

DRAWING NAME :

REVISION :		SCALE :
NO	DATA	DESCRIPTION
1		FOR QUOTATION
2		
3		

1 : 1

SHEET NO :
09

TOTAL SHEET :



หมายเหตุ : จุดติดตั้ง Inverter และ ตู้ไฟ AC/DC โซล่าเซลล์

ผู้ว่าจ้างอนุมัติแบบ



DESIGNER : DC SOLAR	ELECTRICAL ENGINEER : Mr.Jittapu Sriboonrueang		PROJECT NAME : โรงพยาบาลสองแคว 80.4 kW		REVISION :		SCALE : 1 : 1
	PROFESSIONAL ENGINEER : Mr.Athiwat Saeio		DRAWING TITLE : SOLAR Panel		NO 1	DATA FOR QUOTATION	SHEET NO : 10
	APPROVED : Mr.Tossapon Jarukornvanont		STRUCTURAL ENGINEER : Mr.Arnon Saewu		2		
					3		TOTAL SHEET :